



**TG · TH · TP · MP · OP** Series HMI

# TG series HMI, New product



High quality display, High-speed cache, High-speed download, High-speed startup

7"	8"
TG765-MT TG765-UT TG765-ET	TG865-MT TG865-UT TG865-ET
<ul style="list-style-type: none"> <li>16million true color TFT-LCD</li> <li>800*480 pixels</li> <li>128MB memory</li> </ul>	<ul style="list-style-type: none"> <li>16million true color TFT-LCD</li> <li>800*600 pixels</li> <li>128MB memory</li> </ul>
PORT1: RS232/RS485    PORT2: RS232/RS485/RS422 MT: USB-B PORT UT: USB-B PORT/USB-A PORT ET: USB-B PORT/USB-A PORT/Ethernet PORT	

*TGA62, TGA65, TGC65 are coming soon!*



TG865

TG765

### 16 million colors and high brightness screen makes the displaying vividly

16 million colors, high brightness TFT-LCD and 800\*600 pixels make TG LCD close to PC LCD.

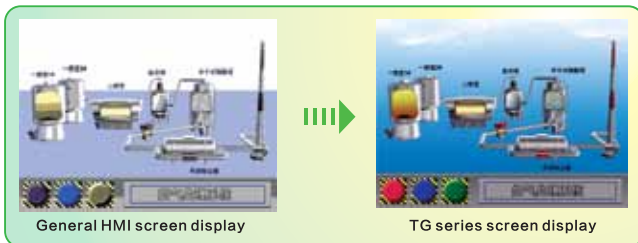

### 128MB memory, improve the processing speed

#### 1 High-speed download

The download speed is 5 times faster than TH series

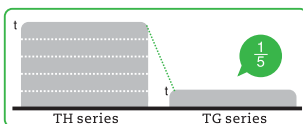

#### 2 High-speed startup

Improve the startup speed



#### 3 High-speed running

Screen jump and animation action is faster

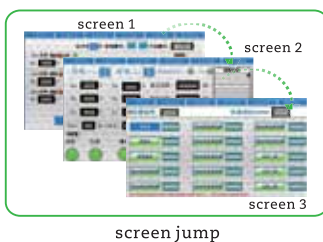

screen jump



animation

### Larger memory capacity

TG has 8MB memory and enables to expand the memory by preloading function. Millions of message can be stored in the memory and checked.

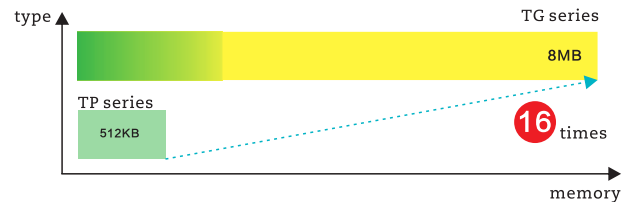

### ET series has Ethernet port

ET series HMI is based on standard Ethernet. It can provide fast data transmission, build open network and perform multi-master-multi-slave communication.

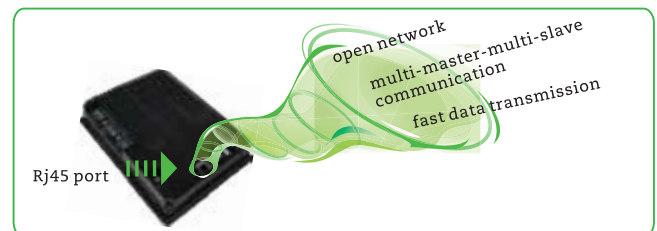

### All the functions of TH series

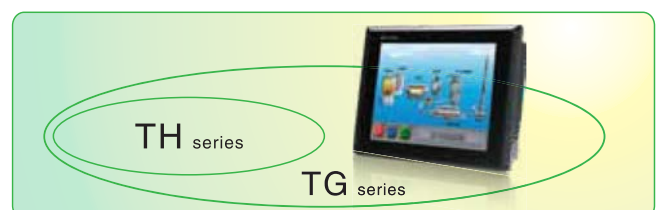

# TH series HMI

## New generation of HMI, 4.3" ~10.4" LCD

10.4"



### THA65-MT/UT



- 65536 colors, true color TFT-LCD
- 800\*600 pixels
- 128MB memory
- Port1: RS232/RS485
- Port2: RS232/RS485/RS422
- USB-B port
- MT: TH standard model
- UT: USB-A port

10.1"



### THA62-MT/UT



- 65536 colors, true color TFT-LCD
- 800\*480 pixels
- 128MB memory
- Port1: RS232/RS485
- Port2: RS232/RS485/RS422
- USB-B port
- MT: TH standard model
- UT: USB-A port

8"



### TH865-MT/UT



- 65536 colors, true color TFT-LCD
- 800\*600 pixels
- 128MB memory
- Port1: RS232/RS485
- Port2: RS232/RS485/RS422
- USB-B port
- MT: TH standard model
- UT: USB-A port

7"



### TH765-NT/NU



- 65536 colors, true color TFT-LCD
- 800\*480 pixels
- 128MB memory
- Port1: RS232/RS485
- Port2: RS232/RS485/RS422
- USB-B port
- NT: TH standard model
- NU: USB-A port

7"



### TH765-NT3/NU3



- 65536 colors, true color TFT-LCD
- 800\*480 pixels
- 128MB memory
- Port1: RS232/RS485(4A7B)
- Port2: RS232/RS485/RS422
- Extension port:RS485(1A6B)
- USB-B port
- NT3: TH standard model
- NU3: USB-A port

4.3"



### TH465-MT/UT

- 65536 colors, true color TFT-LCD
- 480\*272 pixels
- 8MB memory
- Port2: RS232/RS485/RS422
- USB-B port
- MT: TH standard model
- UT: USB-A port

# TH series HMI

## 65536 colors display, high brightness screen

TH series has 65536 colors high brightness and contrast TFT-LCD. It makes the display more vividly.



65536 colors



256 colors

## Enhanced communication ability

### Three ports can communicate at the same time

TH and TP series have port1 (download port) and port2 (PLC port). TH765-NT3 and TH765-NU3 have 3 ports. All the ports can communicate with different devices.

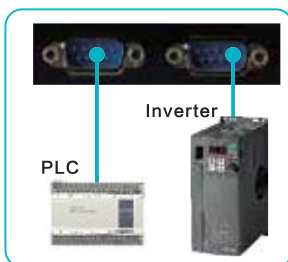

2 ports communication

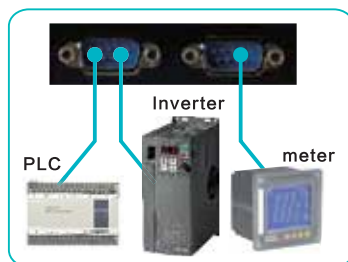

3 ports communication

### Communicate with various devices

- Communicate with PLC (Mitsubishi, Siemens, Omron, Schneider...), inverter (Yaskawa, Mitsubishi, Delta...), and controllers.
- Support Modbus protocol. One port can connect to many devices with Modbus protocol, such as PLC, inverter, servo.

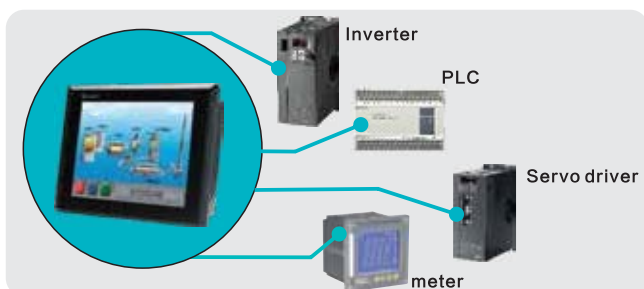

### Support micro-printer

Download port can connect to micro-printer, panel printer and thermal printer. HMI enables to print real-time project data, curve.

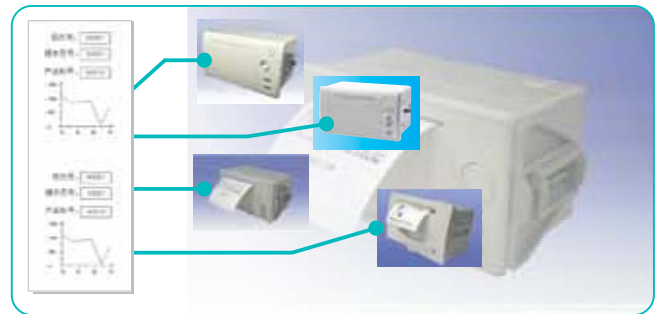

### User-defined protocol breaks the limit of communication protocol

User can define the protocol to communicate with meter, SCM.

## Various networking modes

### The networking modes include one-to-many, many-to-one, many masters-many slaves.

#### One HMI to many PLCs

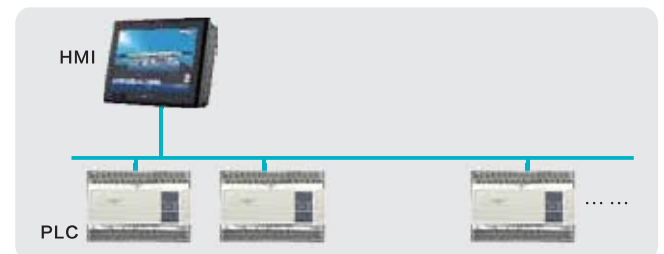

#### Many HMIs to one PLC



#### Many HMIs to many PLCs



## Easy-port design makes the transmission faster

### Front port USB-A is easy to use **NEW**

USB-A port is used to export/import the data. The front port design makes the operation easy.



### Download program through USB-B port

USB-B port accords to USB2.0 standard. It can connect to PC to perform high-speed download.

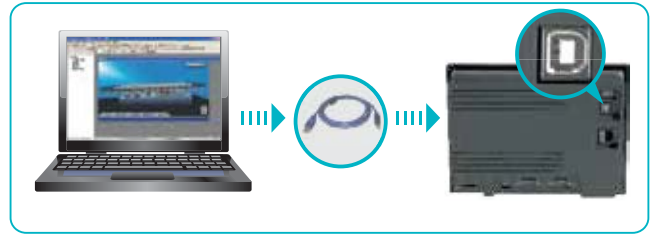

### Download program to HMI through U memory **NEW**

TH (-UT) series has USB-A port. Connect U memory to the port to download program without PC. This way is fast and cost-saving.

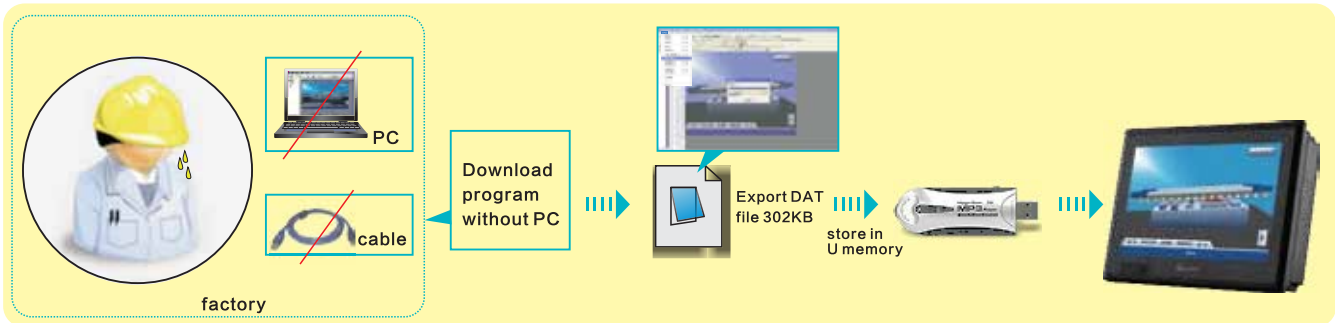

## Complete basic functions

### Various types

4.3"、7"、8"、10.1"、10.4"

### Support different languages

Chinese, English, Arabic, Korean, German, Russian...

### User-defined font and word art

### Built-in clock

- Export the clock time from HMI to other device.
- The min timer is 100ms. It can be used to the timing of data transfer, data up/down and C function calling.
- The clock button is easy to show the real-time clock.

# TP series HMI

4.7"	7"
<b>TP460-L</b>	<b>TP760-T</b>
<ul style="list-style-type: none"> <li>■ blue, monochrome LCD</li> <li>■ 240*128 pixels</li> <li>■ 2MB memory</li> </ul>	<ul style="list-style-type: none"> <li>■ 256 colors, true color TFT-LCD</li> <li>■ 480*234 pixels</li> <li>■ 4MB memory</li> </ul>
PORT1: RS232/RS485 PORT2 : RS232/RS485/RS422	



# MP series operate panel

Integrated with display, touch and buttons(MP)

3.7"	7"
<b>MP325-A</b>	<b>MP760-T</b>
<b>MP325-A-S</b>	
<ul style="list-style-type: none"> <li>blue, monochrome LCD</li> <li>192*64 pixels</li> <li>64KB memory</li> </ul>	<ul style="list-style-type: none"> <li>256 colors, true color TFT-LCD</li> <li>480*234 pixels</li> <li>4MB memory</li> </ul>
<b>PORT1</b>   MP325-A:RS232、RS422 MP325-A-S:RS232、RS485 20 function buttons, built-in RTC	<b>PORT1</b> : RS232、RS485 <b>PORT2</b> : RS232、RS485、RS422 26 function buttons, built-in RTC



MP760-T



MP325-A  
MP325-A-S

# OP series operate panel

3.7"	3.7"
<b>OP320</b>	<b>OP330</b>
<b>OP320-S</b>	<b>OP330-S</b>
<ul style="list-style-type: none"> <li>Blue STN-LCD</li> <li>192*64 pixels</li> <li>64KB memory</li> </ul>	<ul style="list-style-type: none"> <li>Blue STN-LCD</li> <li>192*64 pixels</li> <li>64KB memory</li> </ul>
<b>PORT1</b>   OP320:RS232、RS422 OP320-S:RS232、RS485 7 function buttons	<b>PORT1</b>   OP330:RS232、RS422 OP330-S:RS232、RS485 26 function buttons, built-in RTC



OP320  
OP320-S



OP330  
OP330-S

## Applied basic functions

### Two ports for communication

MP760-T and MP360-L have port1 and port2. Both ports can communicate individually.



### Vivid screen and gallery

MP760-T and MP360-L include all the functions of TP series. They have abundant fonts and gallery. 4MB memory is fit for large project.

### The display area is able to touch

The display area of MP series can be touched. It makes the operation easier.



# Screen edit software

## Touchwin software for TG, TH, TP, MP series products

### C function block NEW

C function block includes all the functions of C. It can make complicated calculation, communication protocol and so on.

### Include most of the C functions

```

1 BYTE snd[8]=(0x01,0x01,0x40,0x00,0x00,0x00,0x00,0x00);
2 //定义发送数据数组,并且给数组赋值,数组长度8
3
4 BYTE rcv[7]; //定义接受数据数组,数组长度7
5
6 //对发送数组前6个数据进行Crc校验
7 snd[6]=HIByte(Crc(snd,6));
8 snd[7]=LOByte(Crc(snd,6));
9
10 Enter(PLC); //获取PLC串口资源
11
12 Send(PLC,snd,8); //通过Send函数向串口发送数据
13 Receive(PLC,rcv,7,1000,6);
14 //将从串口接收到的数据存到rcv数组中
15
16 PSM[300]=rcv[3]; //将数组rcv[3]数据收到PSM中
17 Leave(PLC); //释放串口资源
    
```

Make driver program through C

Support standard C functions calling

### Easy way to make animation

- Easy to make animation, user-defined motion trace
- The animation motion includes translation and rotation

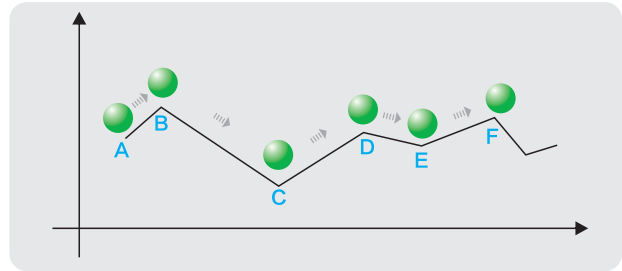

Translation

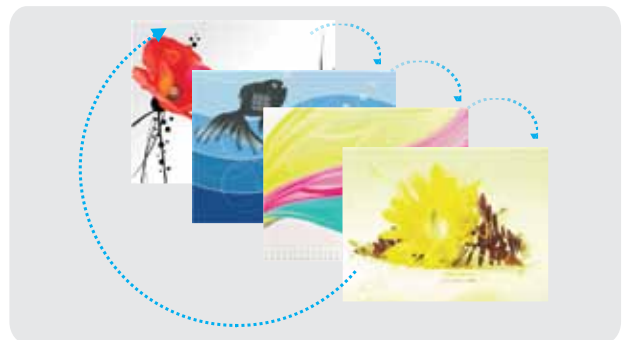

Rotation

### Enhanced vision effect

#### 3D gallery and elements

- System gallery includes meter, fans, valve, pipe, motor, pump and so on.
- Design the elements through line, circle, rectangle, polygon and so on.
- Support bmp and jpg format picture
- Club-shape and cylinder-shape map

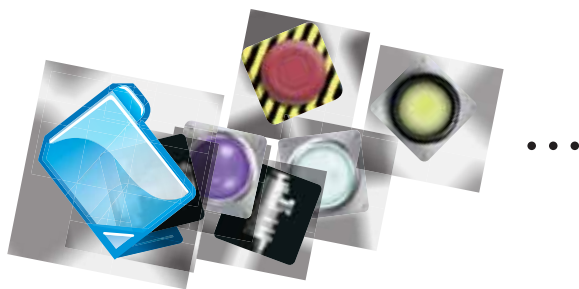

### Enhanced data process ability

#### Data acquisition function, trend map displaying

- The trend map includes real-time map, history map, time map, XY map, XY curve map, bar map. These maps can show the production situation and running status.
- The curve can be zoomed in/out, paged up/down and cleared through event button.
- Read the data at certain time through data grid control button.



### Various language

#### High performance screen display

- Different language: Chinese, English, German, Russian and so on
- Any fonts and sizes of characters, such as bold, italic
- Different language: Chinese, English, German, Russian and so on
- Wordart effect: projection, stroke, fill, etc.

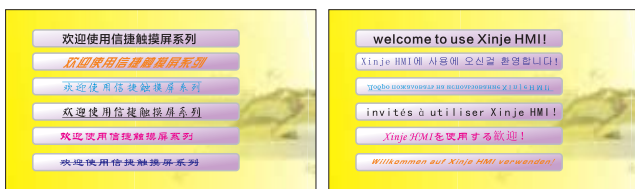

## Recipe export/import function

Users don't have to input the parameter one by one in the HMI. Store the working parameters as the recipe in csv file in the U memory. Export the recipe from the U memory to the HMI. It will improve the working efficiency.



## Enhanced alarm function

- Alarm function enables the user to identify process issues quickly
- History event button can record the history alarm message
- Page up/down and clear the alarm list by event button



## Buzzer alarms

- The buzzer has different sound modes for the alarm level.

## Password protection function

### 9 levels password, user-defined authorization

The password level decides the user authorization.

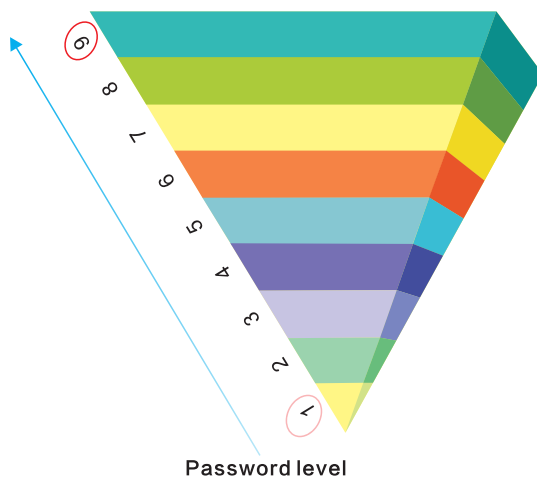

## Program encryption

Export the program as dat format. Copy the dat file in U memory and download to the HMI. However user cannot see the contents in the file.

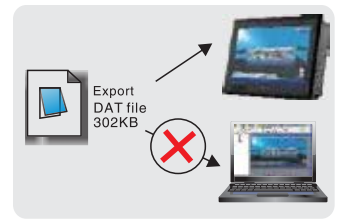

## Advanced function

The advanced function includes logical calculation, trigonometric function, arithmetical operation and so on.

## Download CAD motion program

With the Xinje motion control technical, it can export the file from U memory to HMI through USB-A port. Then transfer the file from HMI to PLC. The cutting parameters can be transferred from PLC to HMI.

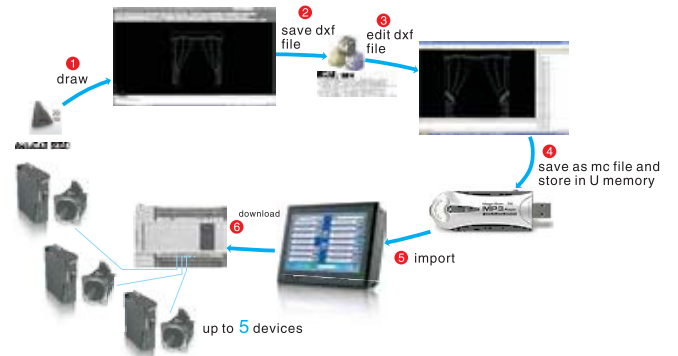

## Database management

Data export function includes data acquisition and data export. It is fit for mass data management.

### Export the data to U memory

The data can be exported to U memory in csv format. The csv file also can be imported to the HMI.

时间	一区日使用率 (%)	二区日使用率 (%)	三区日使用率 (%)	总体日使用率 (%)
1				
2	10:54:28 15	13	10	25.4
3	10:54:28 13	31	29	60
4	10:54:28 29	10	18	52.8
5	10:54:28 10	16	20	42.6
6	10:54:28 32	32	33	85.2
7	10:54:28 30	28	25	72.2
8	10:54:28 5	15	33	49.1
9	10:54:28 35	11	30	70.4
10	10:54:28 10	35	18	60.3

### Backup the data in PC

1. The csv file can be saved in PC disk and open the file through Excel. All the data can be imported into the report forms of HMI.

2. The report form system can be made by data grid control button. It can show the history and real-time data.



## Emulation

The emulation function includes offline/online emulation and SCADA. Touchwin SCADA can emulate the control between HMI and Xinje PLC.

### Offline emulation



### Online emulation

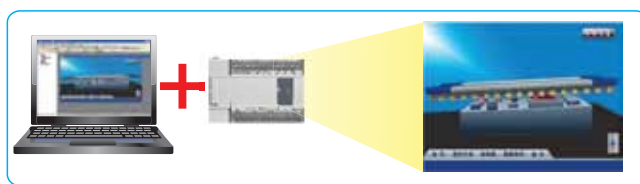

### SCADA



# Product specifications

## TH, TG series product specifications

Product specifications	THA65 series	THA62 series	TG865 series	TH865 series	TG765 series	TH765 series	TH465 series	
	THA65-MT/UT	THA62-MT/UT	TG865-MT/UT/ET	TH865-MT/UT	TG765-MT/UT/ET	TH765-MT/UT/NT/NU/NT3/NU3	TH465-MT/UT	
Dimension(inch)	10.4	10.1	8		7		4.3	
Resolution	800*600	800*480	800*600		800*600		480*272	
LCD	TFT-LCD,LED backlight							
Color	65536 true color		16 million true color	65536 true color	16 million true color	65536 true color		
Luminance	Unadjustable		Adjustable	Unadjustable	Adjustable	Adjustable(except MT/UT)	Unadjustable	
Touch panel	4 wires resistance mode							
Using life	>50,000 hours, 25°C, 24 hours running							
Memory	128M							
Interface	PLC port RS232/RS422/RS485							
Download port	RS232/RS485							
USB	Standard USB2.0 port(USB-A criterion, USB-B criterion)							
Ethernet	\	Standard RJ45 port(only ET)		\	Standard RJ45 port(only ET)		\	
Communication expand port	\					RS485(NT3, NU3 support)		\
Electric	Input voltage DC24V(DC20V~28V)Below 10ms (less than 1s in fact)							
Current consumption	630mA	230mA	190mA	260mA	250mA		130mA	
Allowable momentary power-off	Below 10ms (less than 1s in fact)							
Voltage shock endurance	AC1000V, 20mA less than 1 minute							
Insulation resistance	Above 10M, DC500V							
Environment	Operating temperature 0°C~50°C							
Storage temperature	-20°C~60°C							
Operating humidity	10%RH~90%RH (no condensation)							
Anti-interfere capability	Interfere voltage:1500Vp-p pulse cycle:1mS duration time:1 minute							
Ambient	Non-corrosive gas							
Structure	Cooling method Nature cooling							
External dimension	311.0*234.0*48.0	272.2*191.7*51.2	224.4*170.8*45.5		204.0*150.5*43.9		152.0*102.0*41.8	
Mounting dimension	302.0*225.0	260.2*179.7	211.4*157.8		192.0*138.5		144.0*94.0	

## TP, MP series product specifications

specifications		Product	TP460-L	TP760-T	MP760-T	MP360-L	MP330	MP330-S	MP325-A	MP325-A-S	
Product Features	Dimension(inch)		4.7	7	7	3.7	3.7	3.7	3.7	3.7	
	Resolution		240*128	480*234	480*234	192*64	192*64	192*64	192*64	192*64	
	Color		Monochrome	256 true color	256 true color	Monochrome	Blue LCD				
	Luminance		Adjustable via potentiometer	\			Adjustable via potentiometer				
	Button		\			26					
	Touch panel		Matrix digital touch panel								
	Using life		>50,000 hours, 25°C, 24 hours running			>20,000 hours, 25°C, 24 hours running					
Memory		2M	4M	4M	2M	64K					
Interface	PLC port		RS-232/RS422/RS485								
	Download port		RS-232/RS485				RS-232/RS422	RS-232/RS485	RS-232/RS422	RS-232/RS485	
Electric Features	Input voltage		DC24V(DC20V-28V)								
	Current consumption		630mA	280mA	<260mA	200mA	<140mA				
	Allowable momentary power-off		Below 10ms (less than 1s in fact)								
	Voltage shock endurance		AC1000V, 20mA less than 1 minute								
	Insulation resistance		Above 10M, DC500V								
Environment	Operating temperature		0°C-50°C								
	Storage temperature		-20°C-60°C								
	Operating humidity		10%RH-90%RH (no condensation)								
	Anti-interfere capability		Interfere voltage:1500Vp-p pulse cycle:1mS duration time:1 minute								
	Ambient		Non-corrosive gas								
Structure	Cooling method		Nature cooling								
	External dimension		173.23*121.4*45.1	200.0*148.0*45.0	214.0*200.0*60.3	172.0*121.0*56.5	172.0*121.0*56.5	172.0*94.0*40.0			
	Mounting dimension		165.2*113.4	182.4*134.4	201.5*187.5	164.0*113.0	164.0*113.0	164.0*86.8			

## OP series product specifications

specifications		Product	OP330	OP330-S	OP325-A	OP325-A-S	OP320-A	OP320-A-S	OP320-A-N	OP320	OP320-S
Display	Type		Blue LCD		Blue LCD		Blue LCD			Blue LCD	
	Using life		>20,000 hours, 25°C, 24 hours running								
	Resolution		192*64								
	Contrast		Adjustable via potentiometer								
	Letter setting		Chinese, English, German, French, etc								
	Letter size		Chinese:16*16 32*32 English: 8*16 16*32								
	Button		26					20			7
Interface	Memory		64KB								
	Download port		Normal models support RS-232/422, (-s) models support RS232/485								
Electric	Communication port		\								
	Input voltage		DC24V								
	Voltage scope		DC20V-26V								
	Current consumption		<260mA <140mA								
	Allowable momentary power-off		Below 10ms(less than 1s in fact)								
Environment	Voltage shock endurance		AC1000V, 20mA less than 1 minute								
	Insulation resistance		Above 10M, DC500V								
	Operating temperature		0°C-50°C								
	Storage temperature		-20°C-60°C								
	Operating humidity		10%RH-90%RH (no condensation)								
Structure	Anti-interfere capability		Interfere voltage:1500Vp-p pulse cycle:1mS duration time:1 minute								
	Ambient		Non-corrosive gas								
	Cooling method		Nature cooling								
Structure	External dimension		172.0*121.0*56.5	172.0*94.0*38.3		172.0*94.0*30.0			162.0*102.0*38.0		
	Mounting dimension		164.0*113.0	164.2*86.8		163.0*85.0			156.5*94.0		

# Dimensions (unit: mm)

● THA65-MT/UT

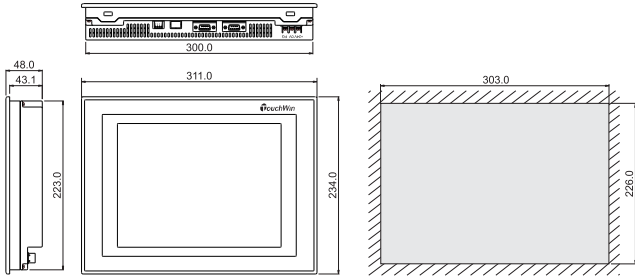

● THA62-MT/UT

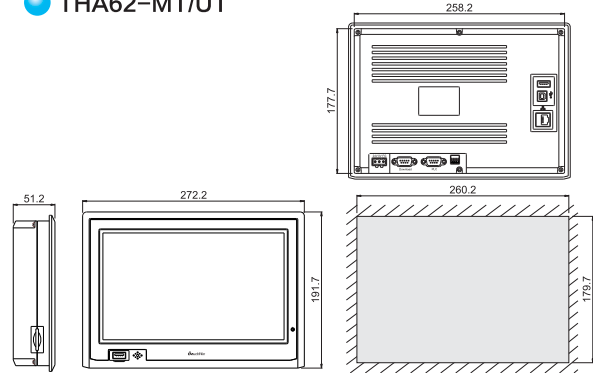

● TG865-MT/UT/ET, TH865-MT/UT

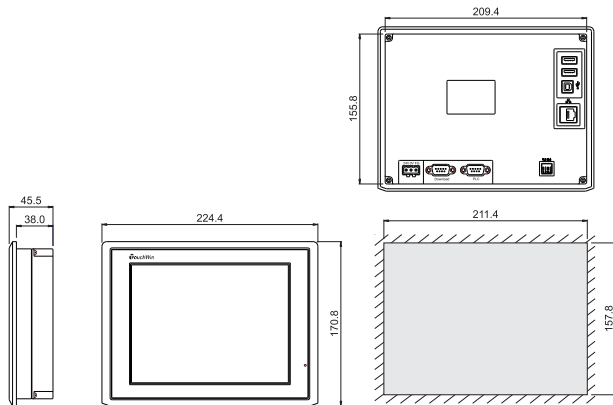

● TG765-MT/UT/ET, TH765-MT/UT, TH765-NT/NU/NT3/NU3

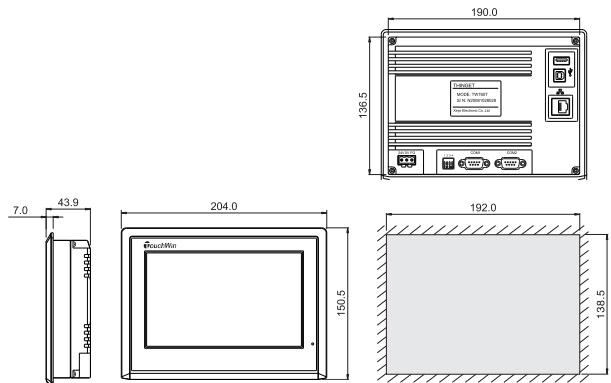

● TH465-MT/UT

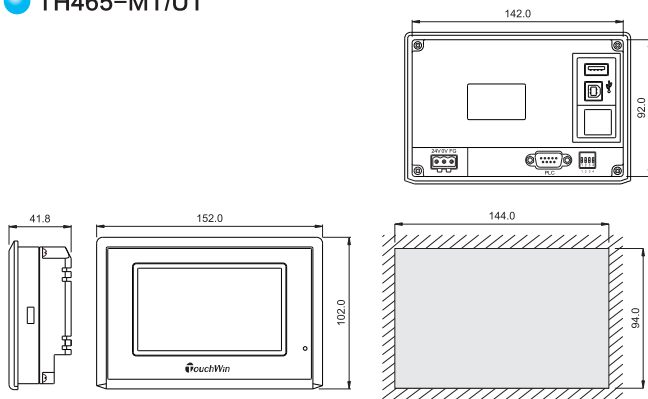

● TP460-L

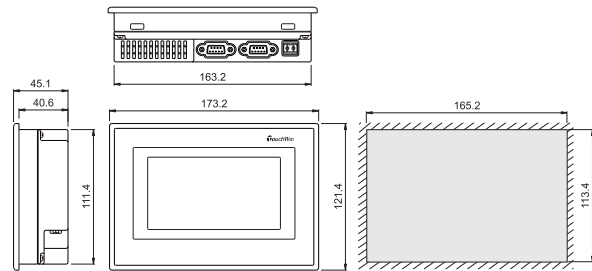

● TP760-T

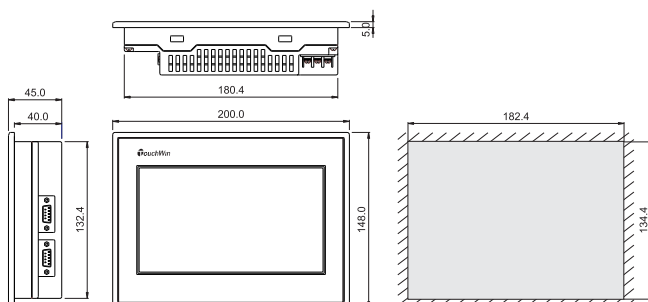

● MP360-L

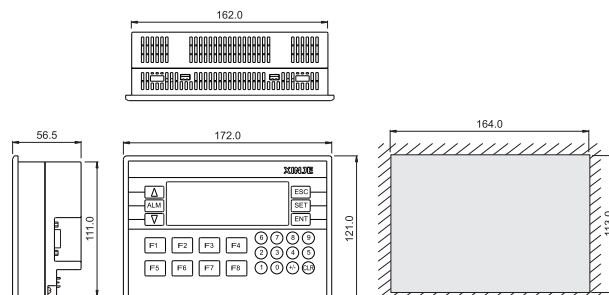

● MP760-T

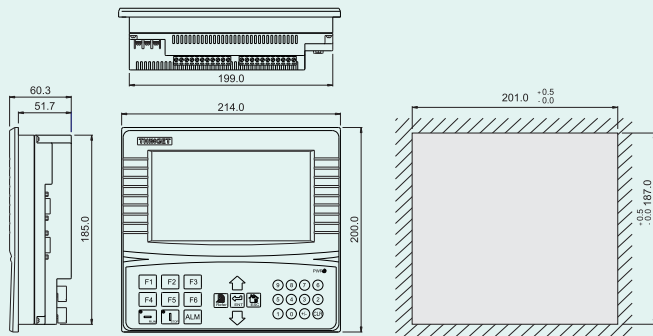

● MP325-A

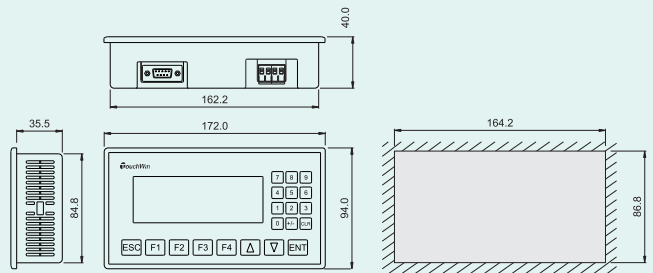

● OP330/MP330

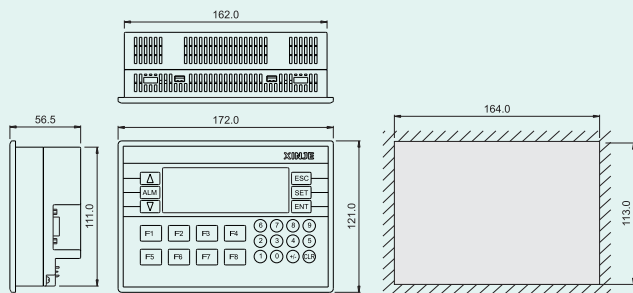

● OP560-L/T

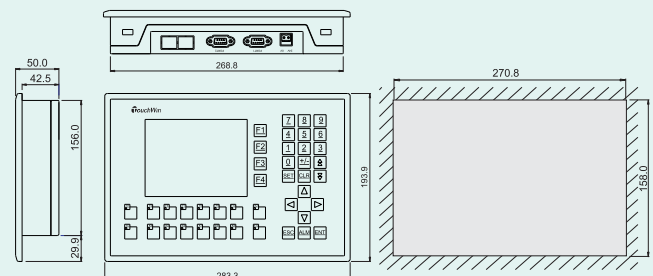

● OP325-A/-A-S

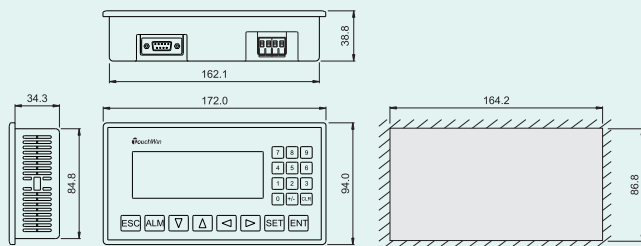

● OP320-A/-A-N/-A-S

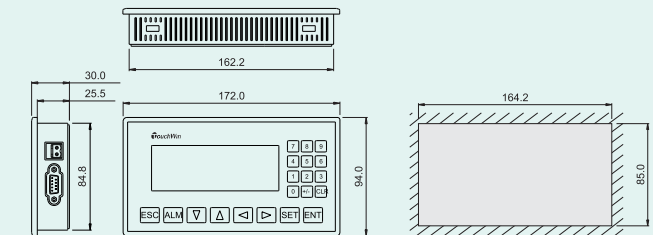

● OP320-S

